

ROZVÁDZAČE IP65 POLYESTEROVÉ NA POVRCH

PEDRO

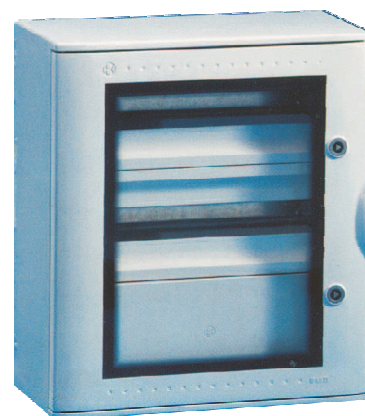

04 605



04 625

Plné dv.	Transp. dv.	v.	š.	hl.	Moduly
04601	04621	303	265	167	
04602	04622	428	325	183	36 (3x12)
04603	04623	504	434	210	54 (3x18)
04604	04624	654	434	210	72 (4x18)
04605	04625	654	543	265	96 (4x24)
04606	04626	806	616	319	140 (5x28)
04608	04628	1056	810	355	190 (5x38)

Technické údaje:

Materiál: Polyesterová skriňa zosilnená skleným vláknom, bezhalogénový sklolaminát

Montáž: Nástenná, s použitím príslušných držiakov

Krytie: Vysoký stupeň krytia IP 65

Trieda izolácie: II, dvojité krytie

Dvere: Plné, alebo transparentné s trojuholníkovým uzáverom

Rozmery: Dodáva sa v rôznych veľkostiach a hĺbkach, do rozmeru 810 x 1060 x 355 mm

Farba: RAL 7035, svetlo šedá

Vnútorne dvere: Osádzajú sa pri požiadavke na vyšší stupeň krytia pri otvorených dverách

Mech. odolnosť: IK 10 (20J)







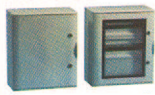

Výbava: Pre priame upevnenie do skrine sú k dispozícii rôzne montážne dosky.

Pre osadenie modulových prístrojov je v ponuke široký sortiment príslušenstva

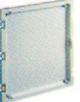
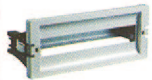

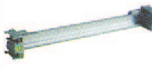
ElektroSystem

www.elektrosystem.sk e-mail: odbyt@elektrosystem.sk T/Fax: 00421 32-640 08 75 MT.: 00421 903-292 678

 Plné dvere: 04 601 Transp. dv.: 04 621 (VTR 01)	Plné dvere: 04 602 Transp. dv.: 04 622 (VTR 02)	Plné dvere: 04 603 Transp. dv.: 04 623 (VTR 03)	Plné dvere: 04 604 Transp. dv.: 04 624 (VTR 04)	Plné dvere: 04 605 Transp. dv.: 04 625 (VTR 05)	Plné dvere: 04 606 Transp. dv.: 04 626 (VTR 06)	Plné dvere: 04 608 Transp. dv.: 04 628 (VTR 07)	
 DOSKA MONTÁŽNA	POZINK: 04 670 PLAST: 04 990 200 x 240 mm	POZINK: 04 671 PLAST: 04 991 240 x 365 mm	POZINK: 04 672 PLAST: 04 992 350 x 440 mm	POZINK: 04 673 PLAST: 04 993 350 x 590 mm	POZINK: 04 674 PLAST: 04 994 460 x 590 mm	POZINK: 04 675 PLAST: 04 995 530 x 740 mm	POZINK: 04 677 710 x 990 mm
 DVERE MONTÁŽNE	●	04631	04632	04633	04634	04635	04637
 DIN S KRYC.ŠTÍTOM	●	04640	04641		04642	04643	04644
 KRYT ZÁSLEPNÝ	●	04645	04646		04647	04648	04649
 LIŠTA DIN	●	04660	04661		04662	04663	04664
 RÁM PRE DIN	●	04651	04652	04653		04654	04655
 ÚCHYT MONTÁŽNY	Oceľ: 04680 Nerez: 04688						04680 04688
 ÚCHYT M.DOSKY	04682						04682
 ROZV. ZÁMOK	04681						04681

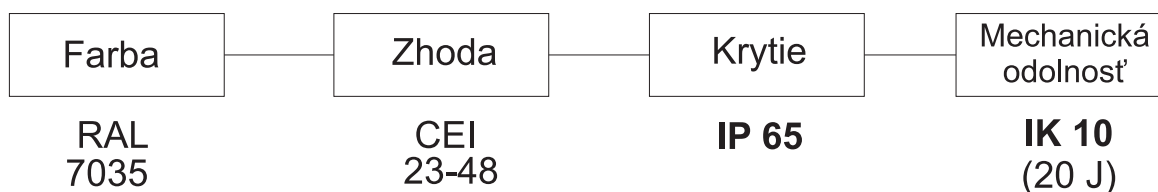

ROZMERY

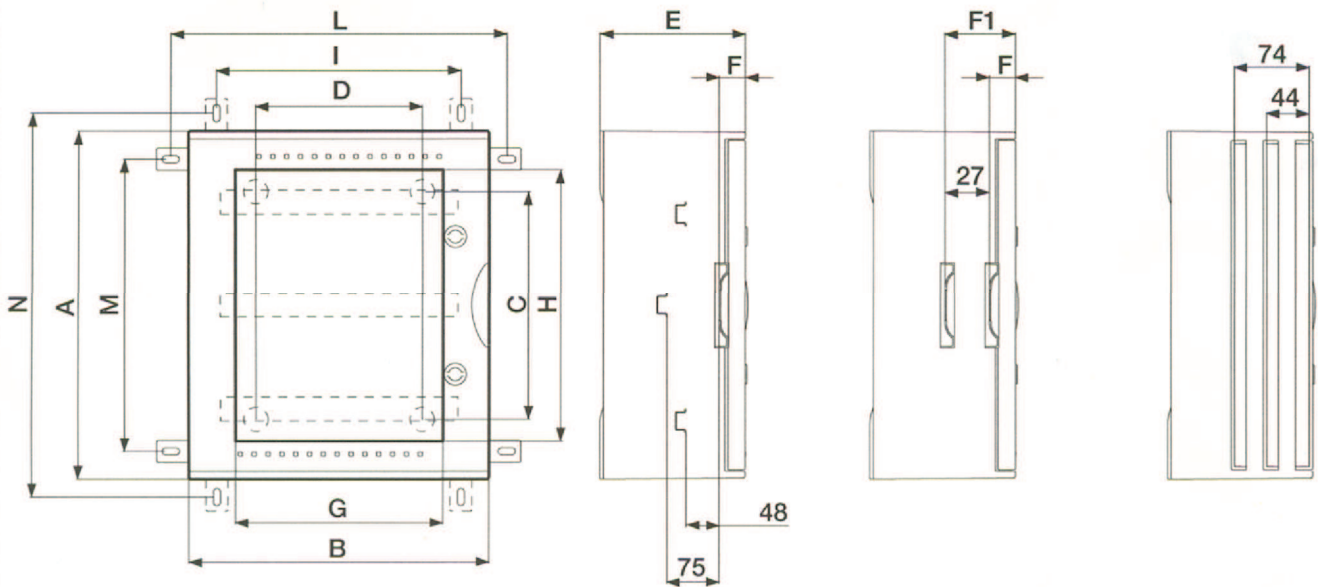

Vyhotovenie	V. Š.	HI.						Kóta							Počet modulov
		A	B	C	D	E	F	F1	G	H	I	L	M	N	
1 VTR 01		303	265	150	110	167	-	-	161	215	184	316	222	354	-
2 VTR 02		428	325	255	132	183	40	67	193	319	245	377	348	480	36 (3x12)
3 VTR 03		504	434	330	240	210	40	67-94	300	393	353	485	423	555	54 (3x18)
4 VTR 04		654	434	480	240	210	40	67-94	300	544	353	485	573	705	72 (4x18)
5 VTR 05		654	543	480	348	265	40	67-94-121-148	405	544	462	594	573	705	96 (4x24)
6 VTR 06		806	616	630	420	319	40	67-94-121-148-175-202	480	694	533	665	723	855	140 (5x28)
7 VTR 07		1056	810	885	600	355	54	81-108-135-162-189-216	639	875	713	845	974	1105	190 (5x38)

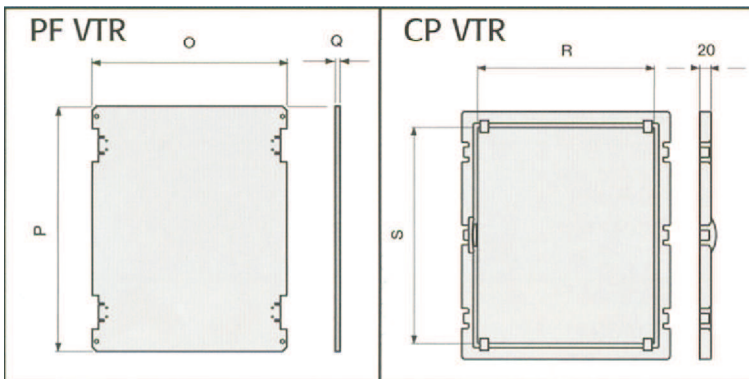

Vyhotovenie	Kóta				
	O	P	Q	R	S
1 PF - CP VTR01	199	240	1,5	-	-
2 PF - CP VTR02	242	365	1,5	210	314
3 PF - CP VTR03	350	440	2	318	389
4 PF - CP VTR04	350	590	2	318	539
5 PF - CP VTR05	458	590	2	425	539
6 PF - CP VTR06	530	740	2	498	689
7 PF - CP VTR07	710	990	2	677	938

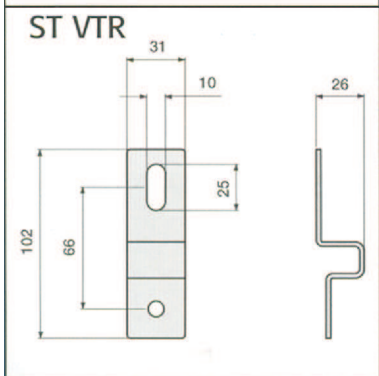

- 7 veľkostí
- veľmi pevná konštrukcia
- variabilné vnútorné vybavenie
- moderný vzhľad
- teplotný rozsah -25 až +60°C
- skúška žeravou sľučkou 960°C pre plné dvere

- skúška žeravou sľučkou 650°C pre transparentné dvere
- zhoda s CEI 23-48 a CEI 23-49
- dvojité krytie  podľa CEI 17-13/1 EN 60439-1
- stupeň ochrany proti vonkajším mechanickým nárazom IK 10

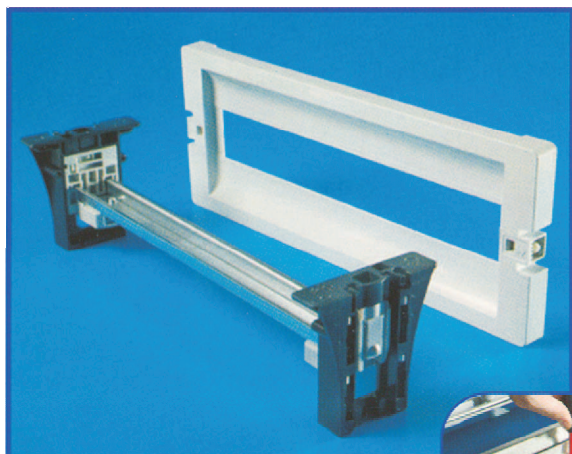

Jednoduchá montáž DIN lišt -
zaistenie pomocou skrutkovača



DIN lišty sú výškovo nastaviteľné pre
štandardné prístroje (48 až 75 mm).
Môže sa použiť aj montážny rám pre
zjednotenie výšky

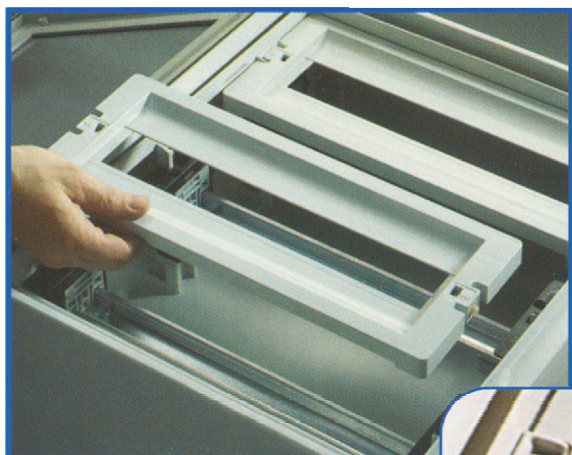

Montáž krycieho štítiku

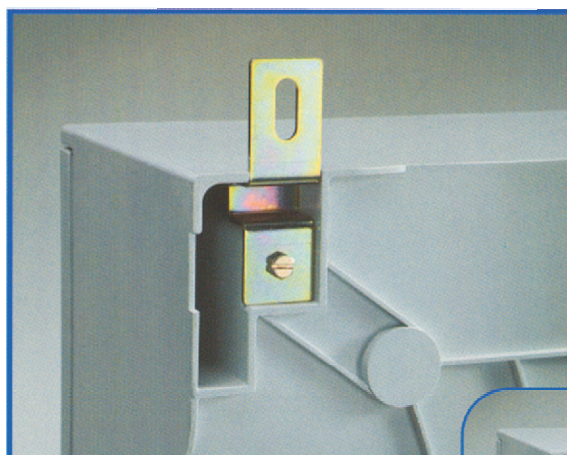
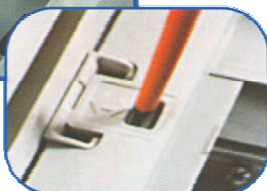

Záves je možné osadiť horizontálne
i vertikálne.
Na objednávku aj nerezový.



Uzáver je možné nahradiť
rozdávateľným zámkom



Montážnu dosku je možné ukotviť
pomocou posuvných zámkov

